

# Sunset

Towel Valet Triple / Armoire à serviettes de bain Triple / Valet de Toallas Triple

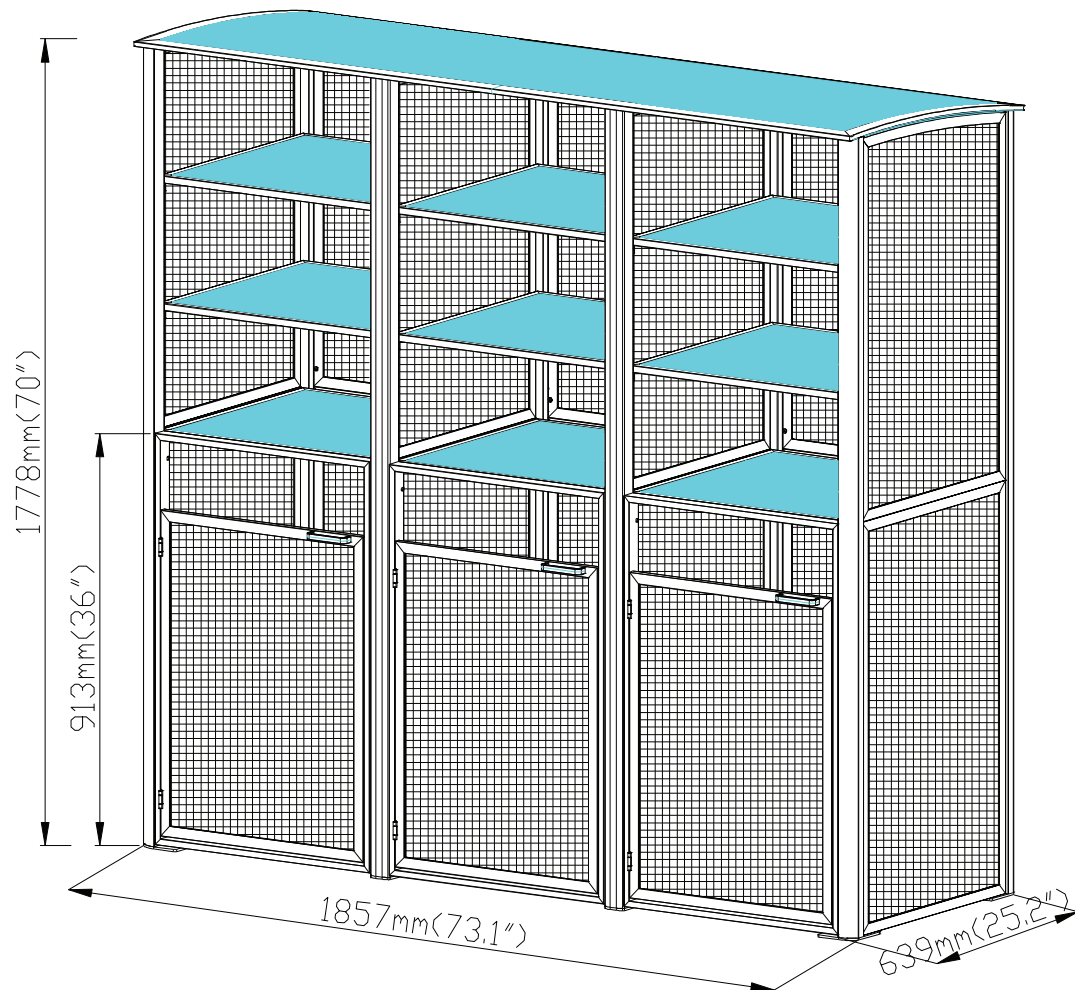

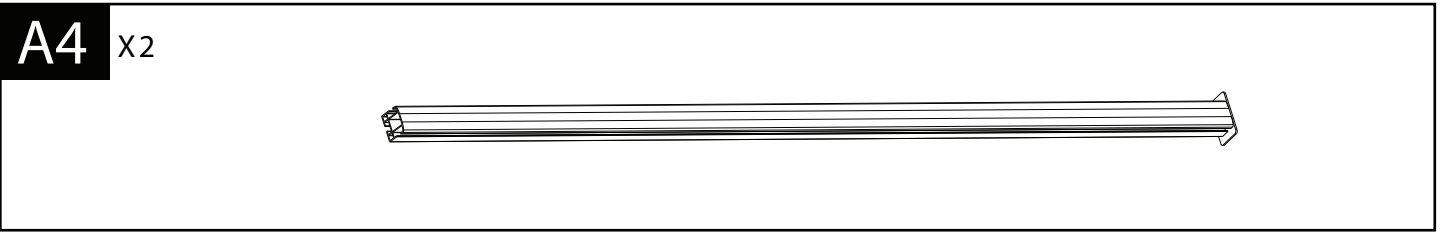
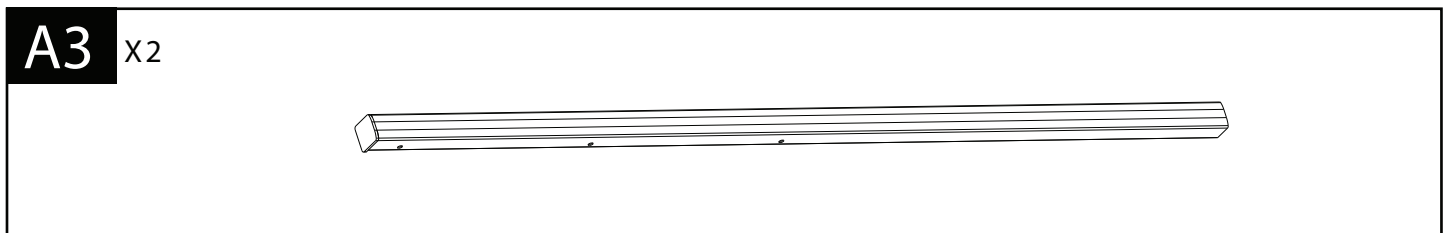
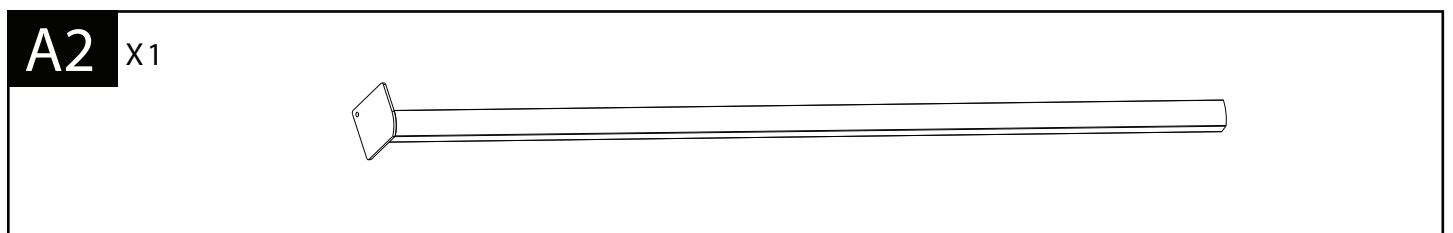
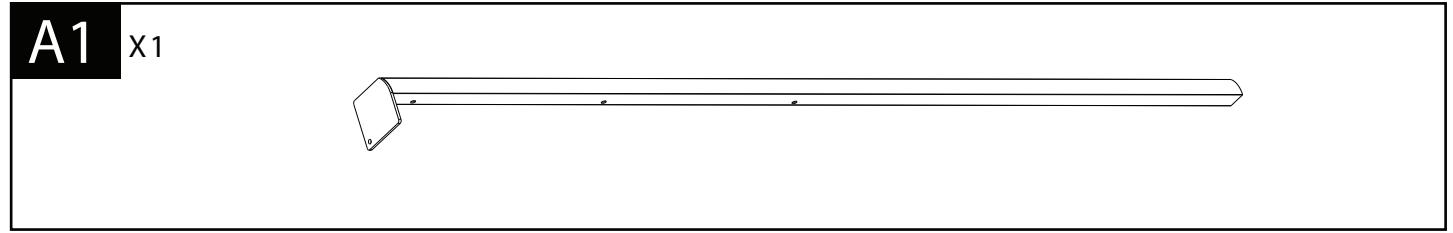
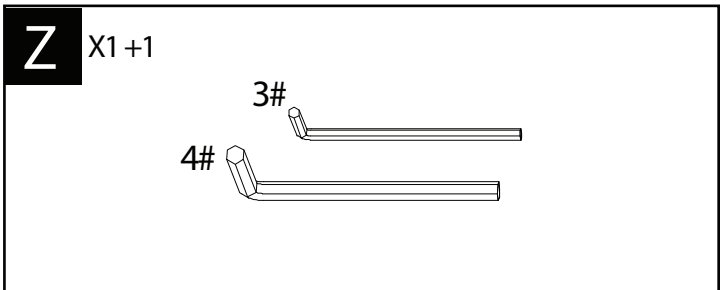
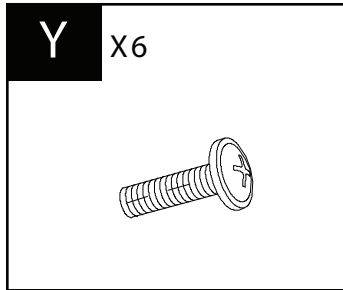
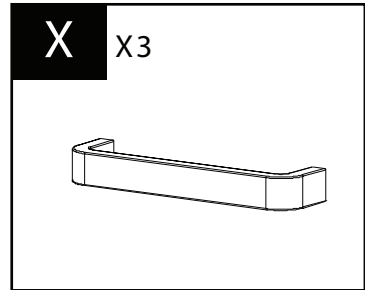
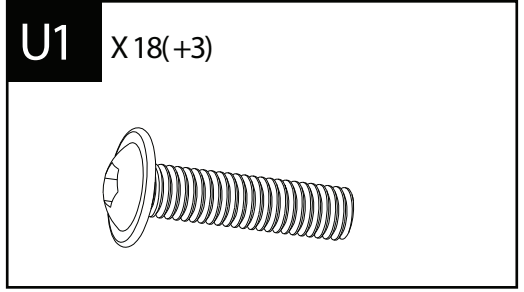
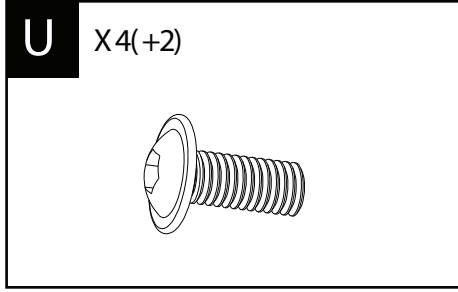
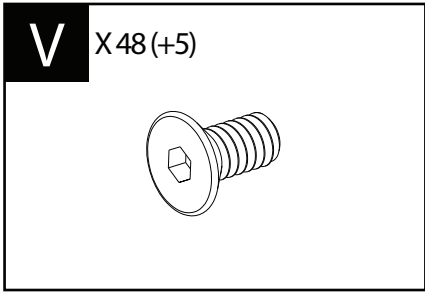

**A5** x1

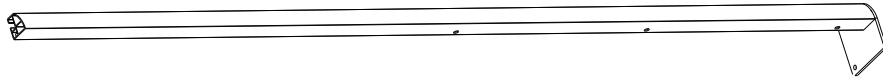

**A6** x1

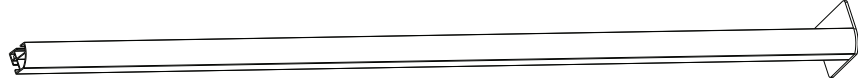

**B** x3

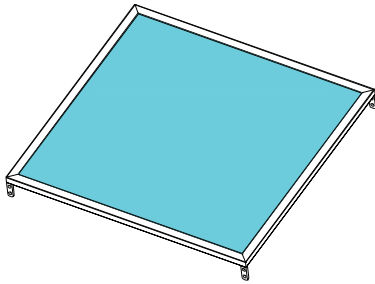

**B1** x6

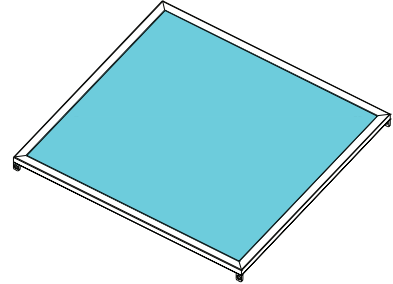

**C** x7

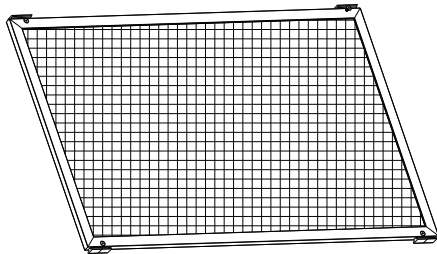

**D** x1

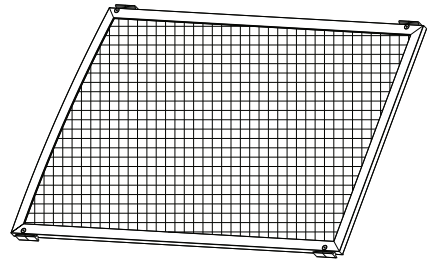

**E** x3

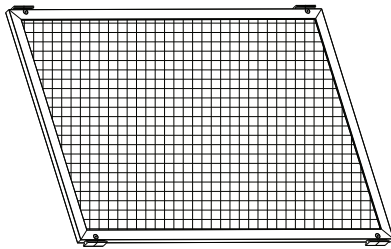

**D1** x3

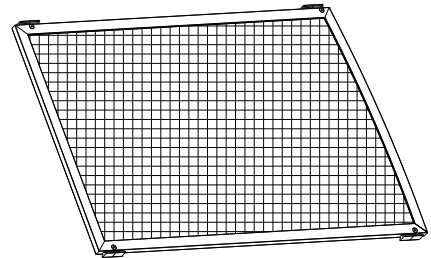

**F** x1

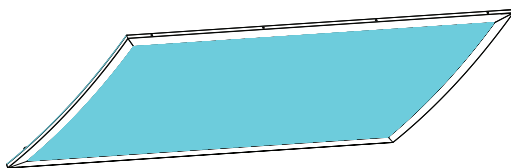

**G** x3

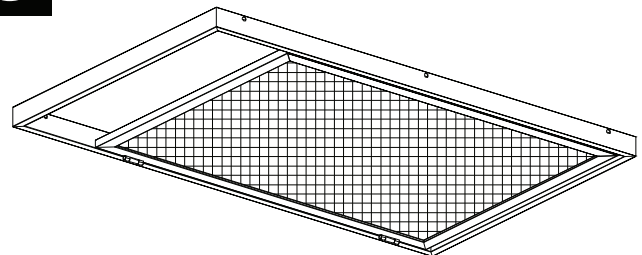

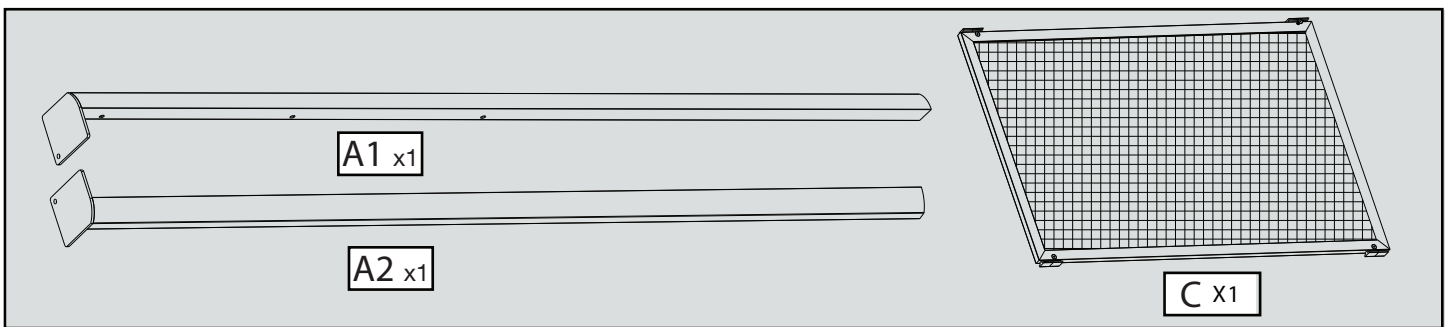
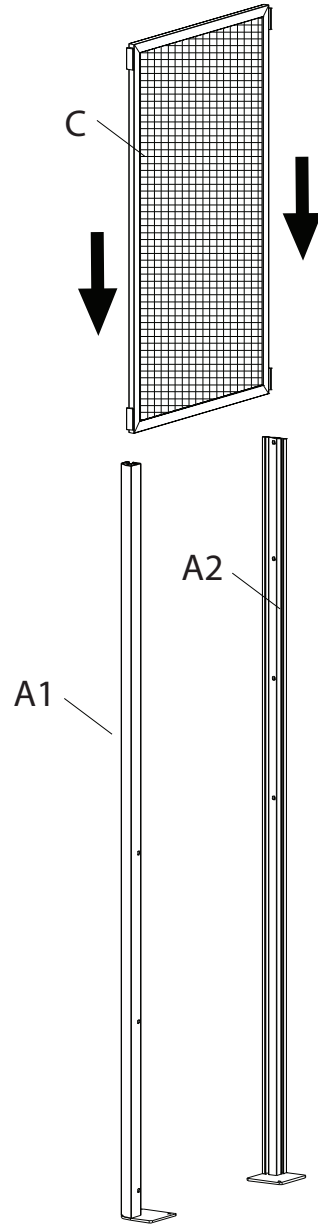

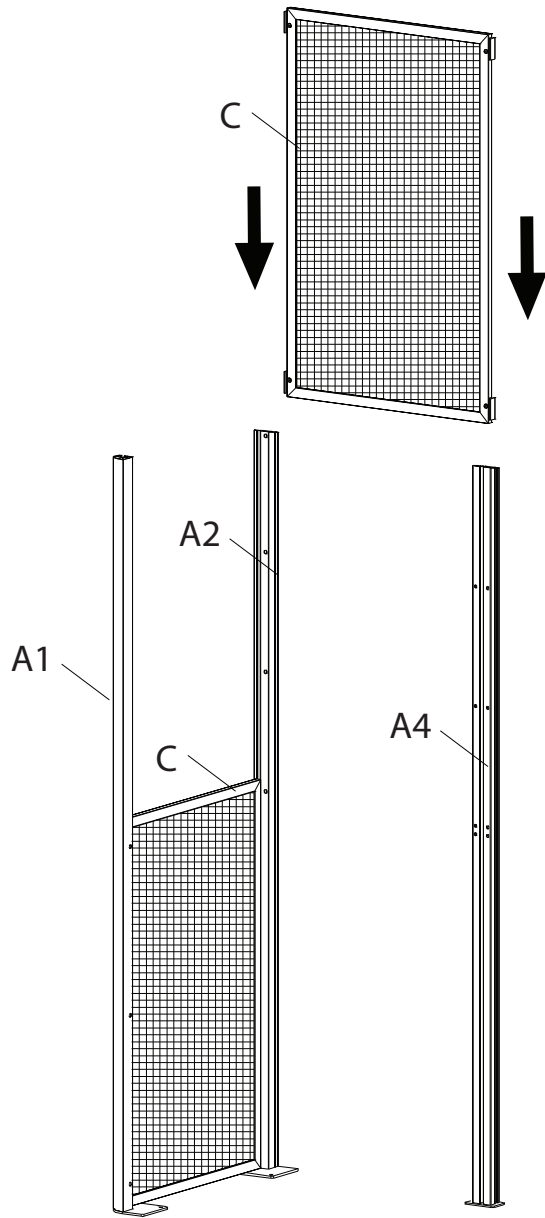

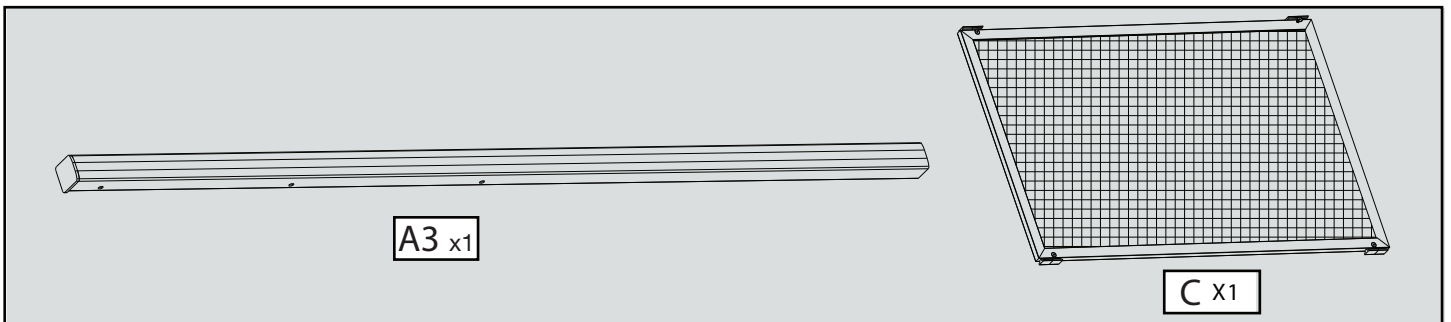
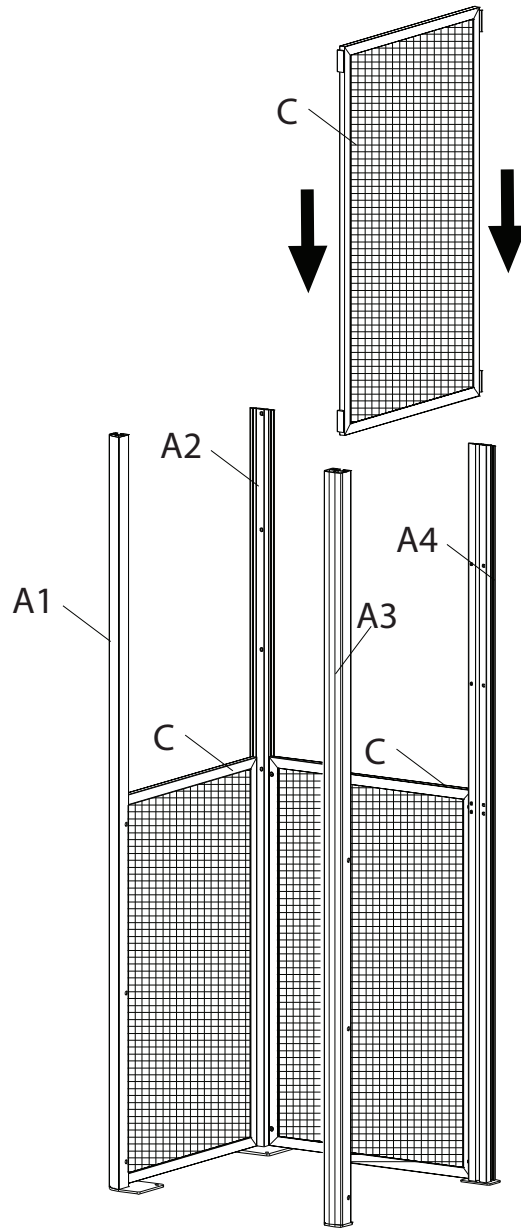

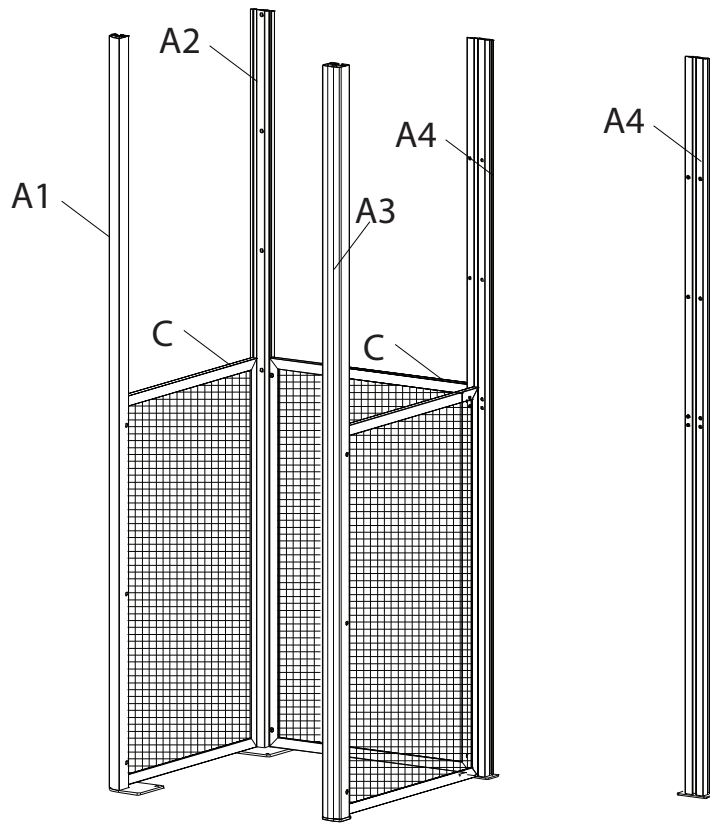
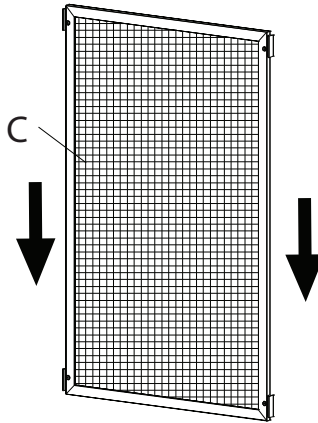

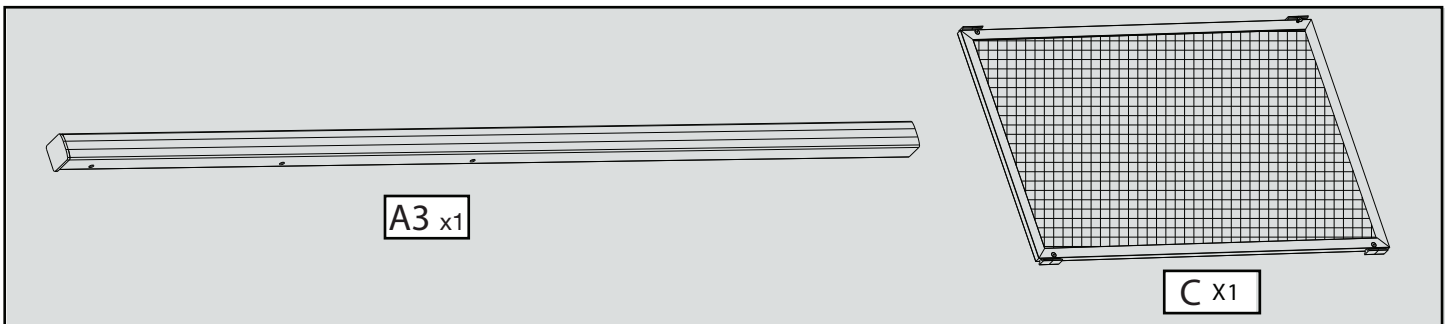
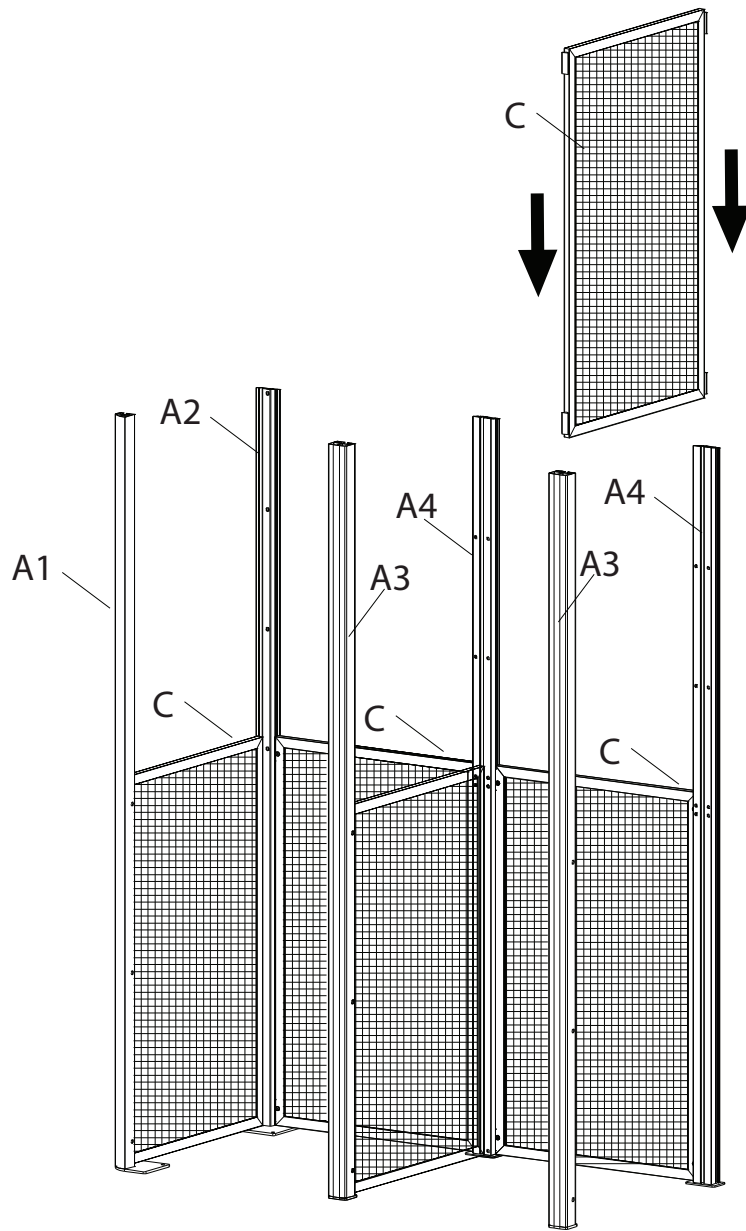



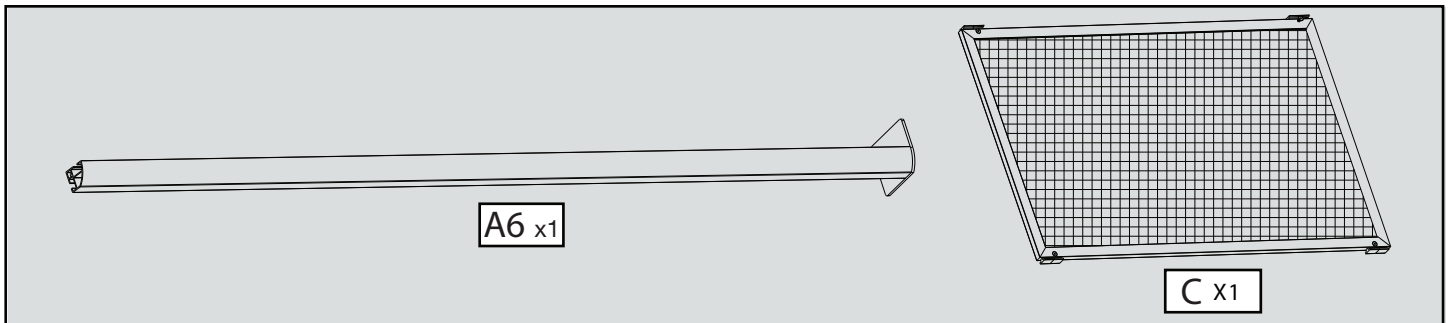
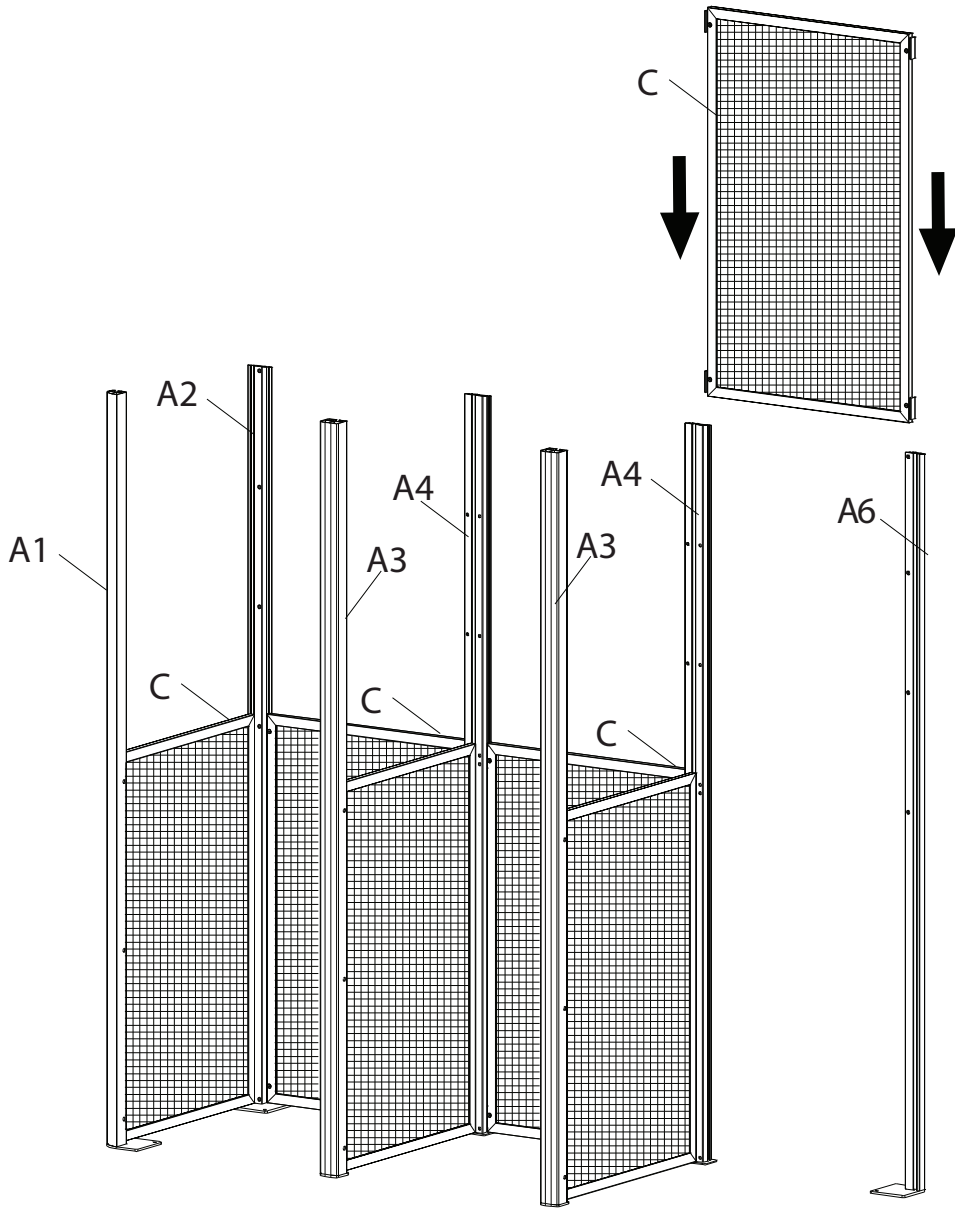

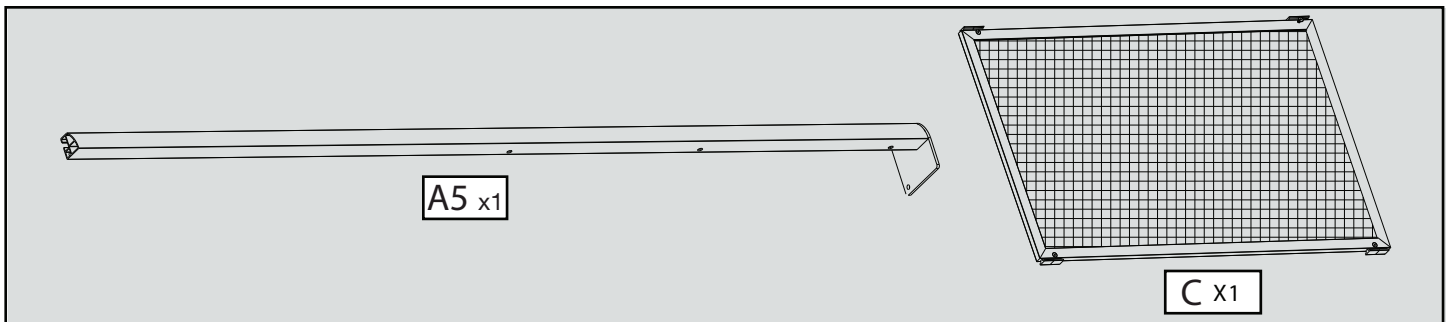
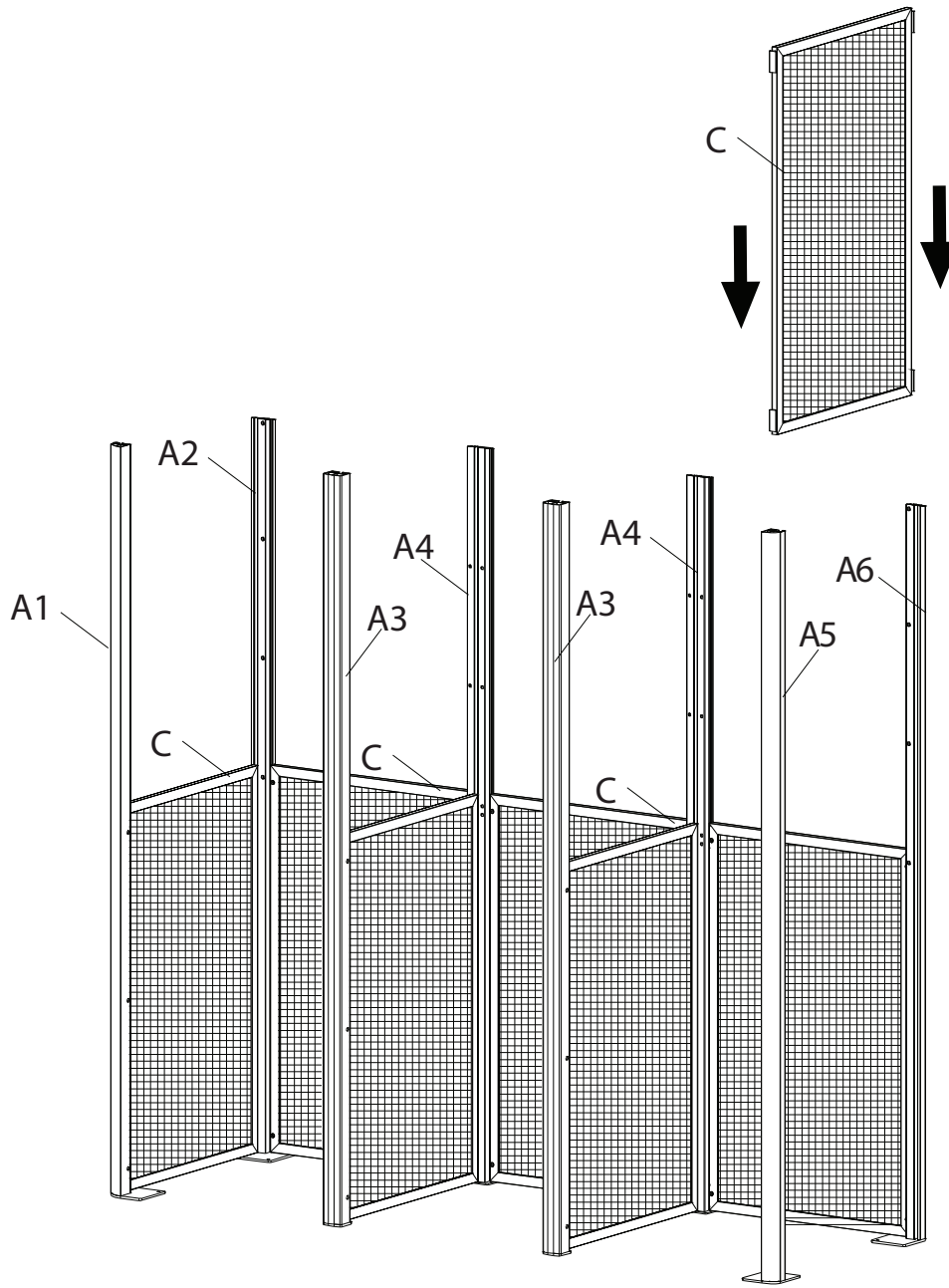

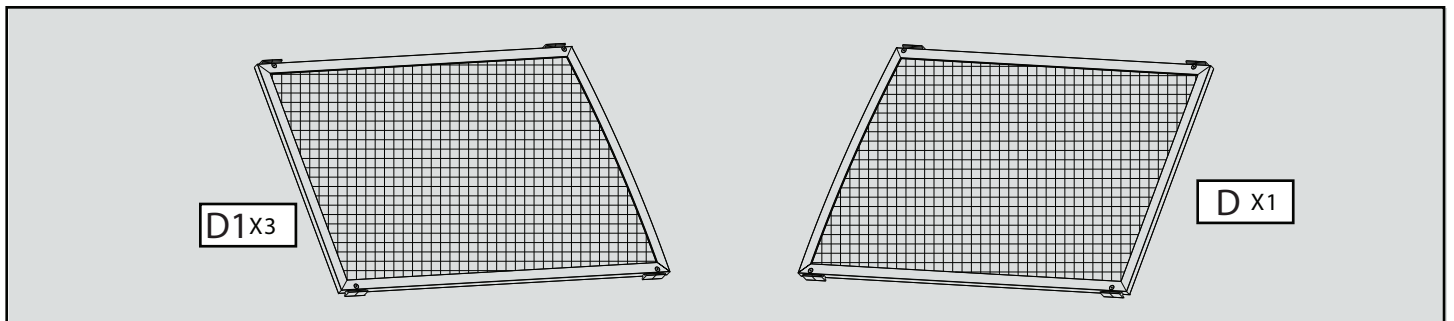
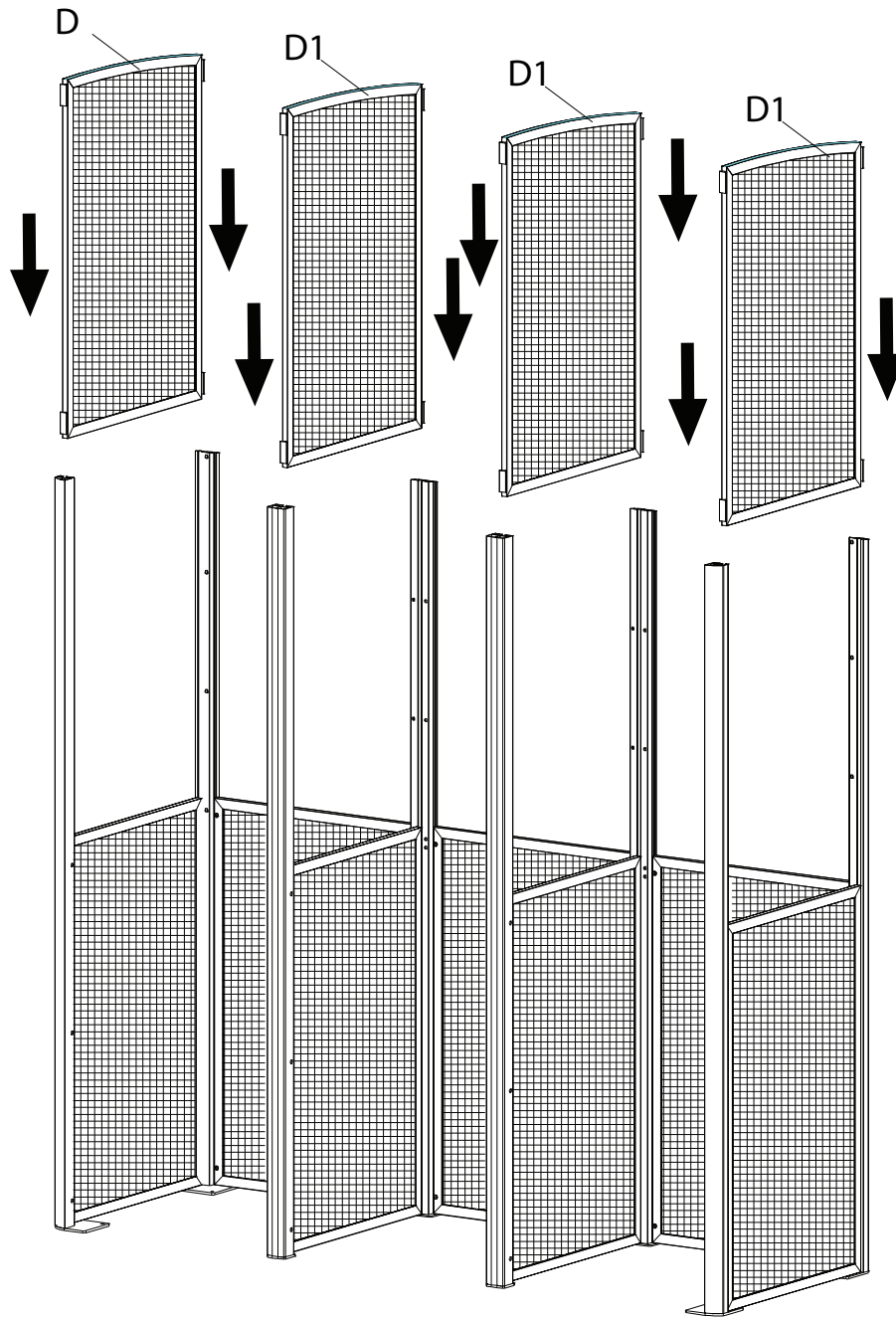

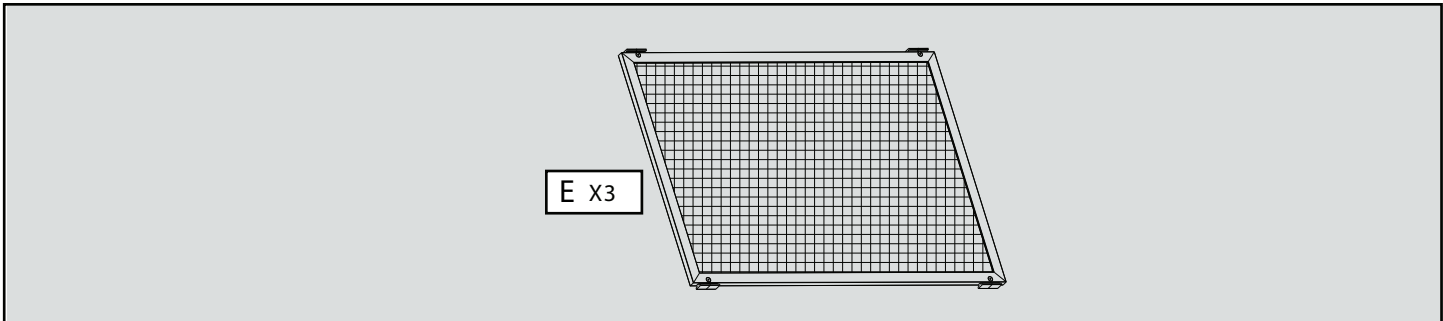
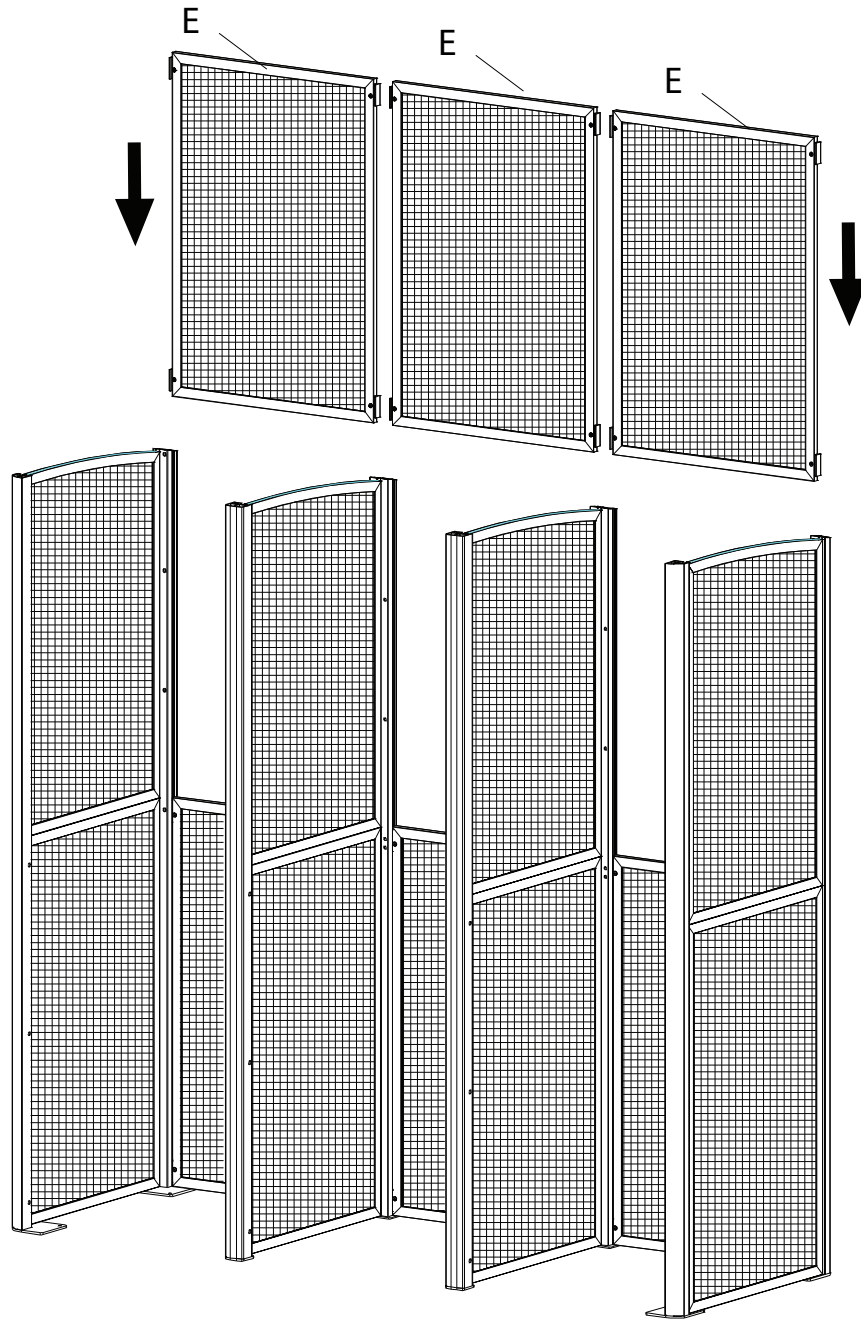

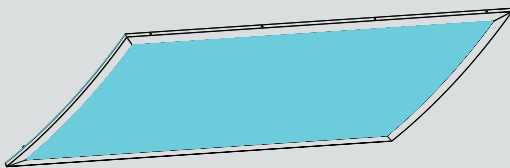
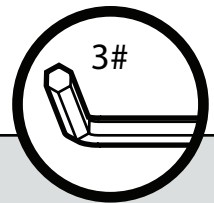
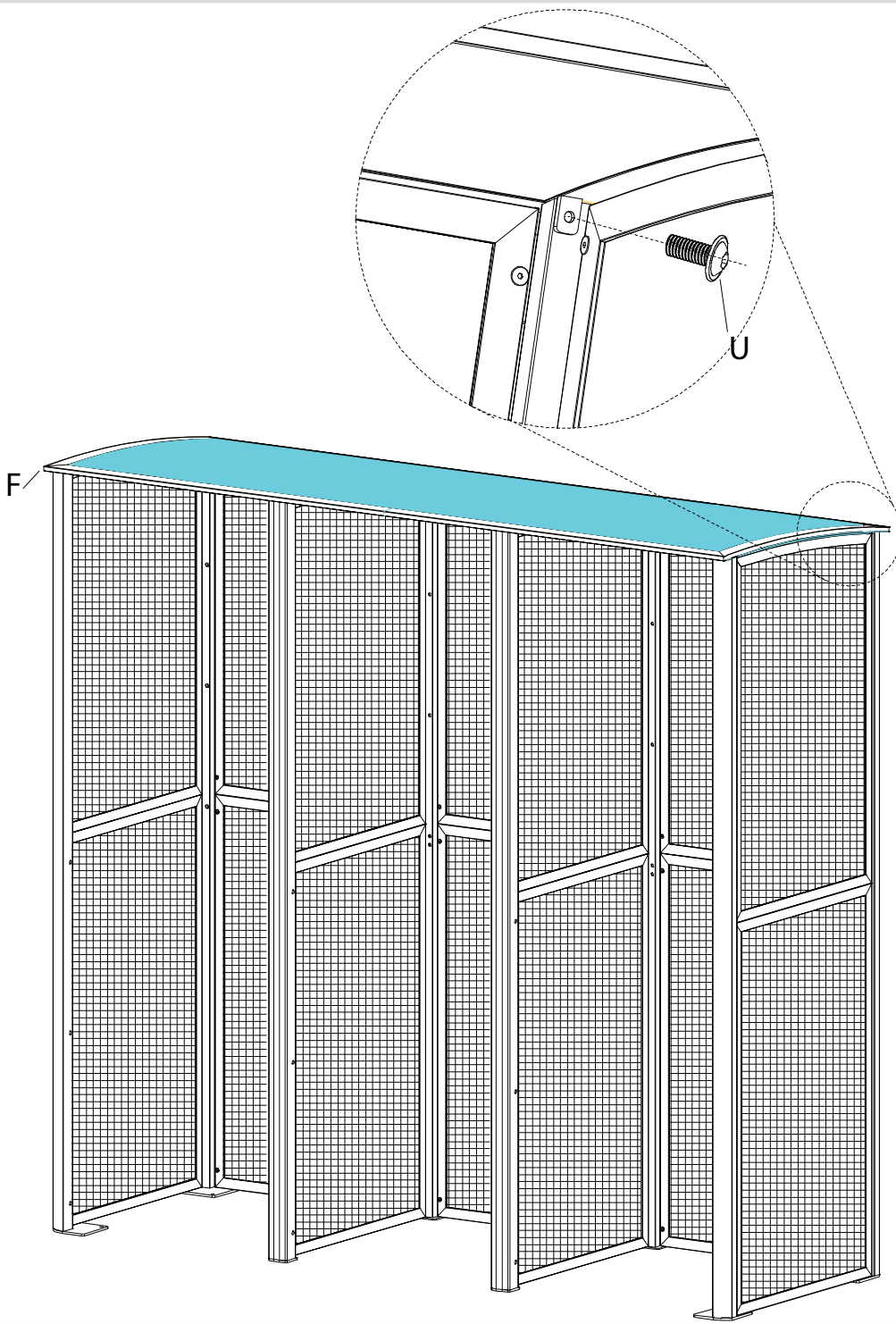

F x1

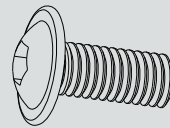

U x4

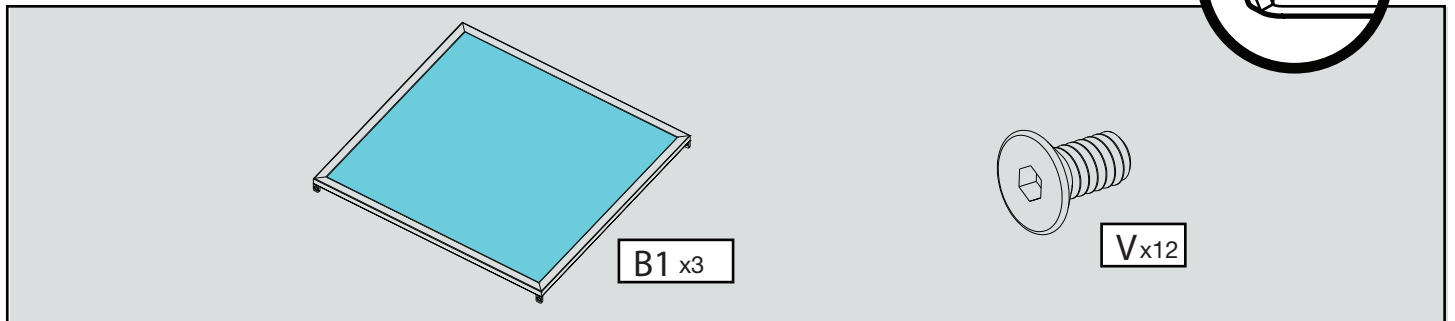
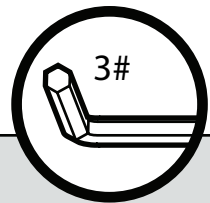
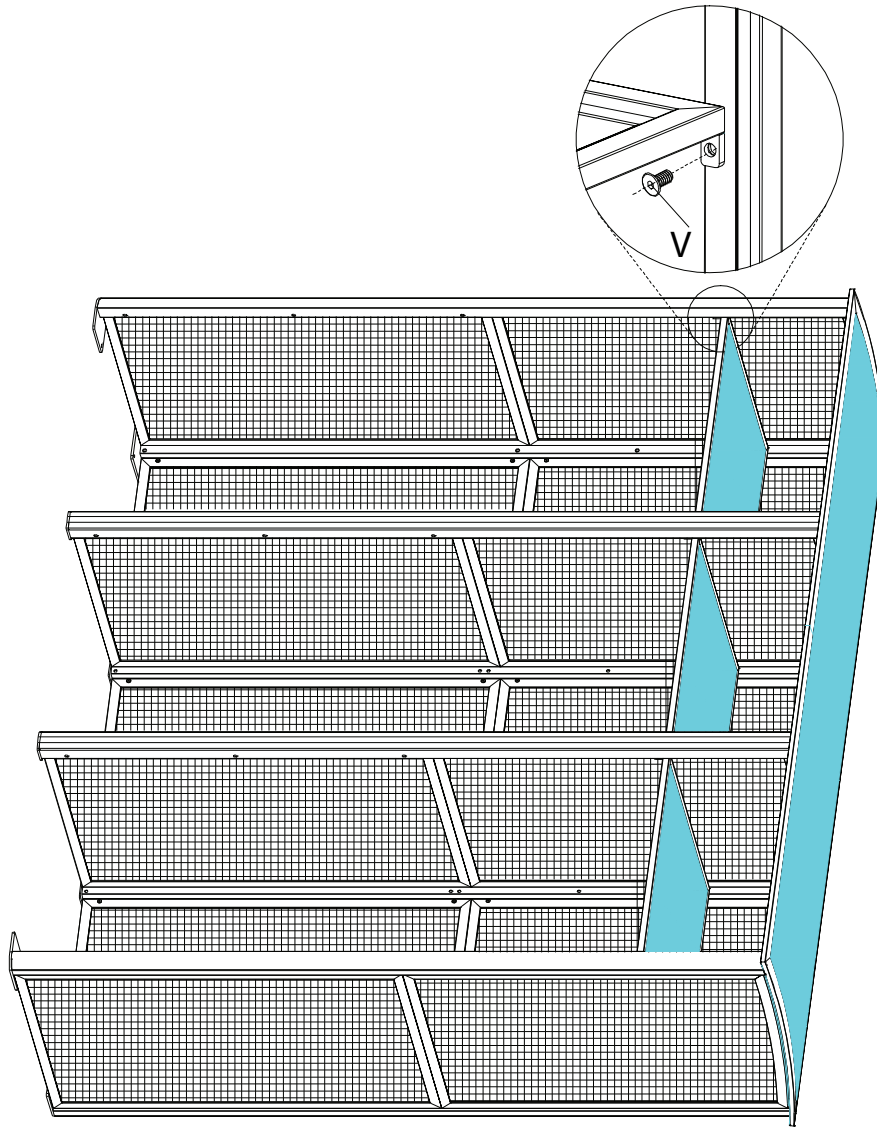

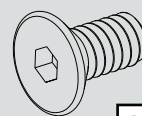
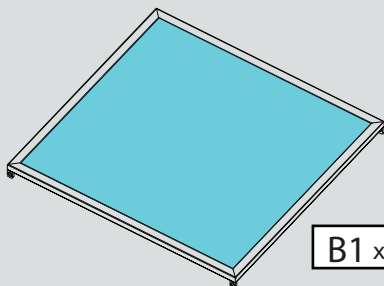
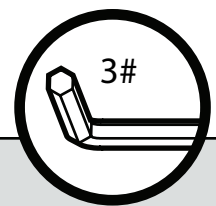
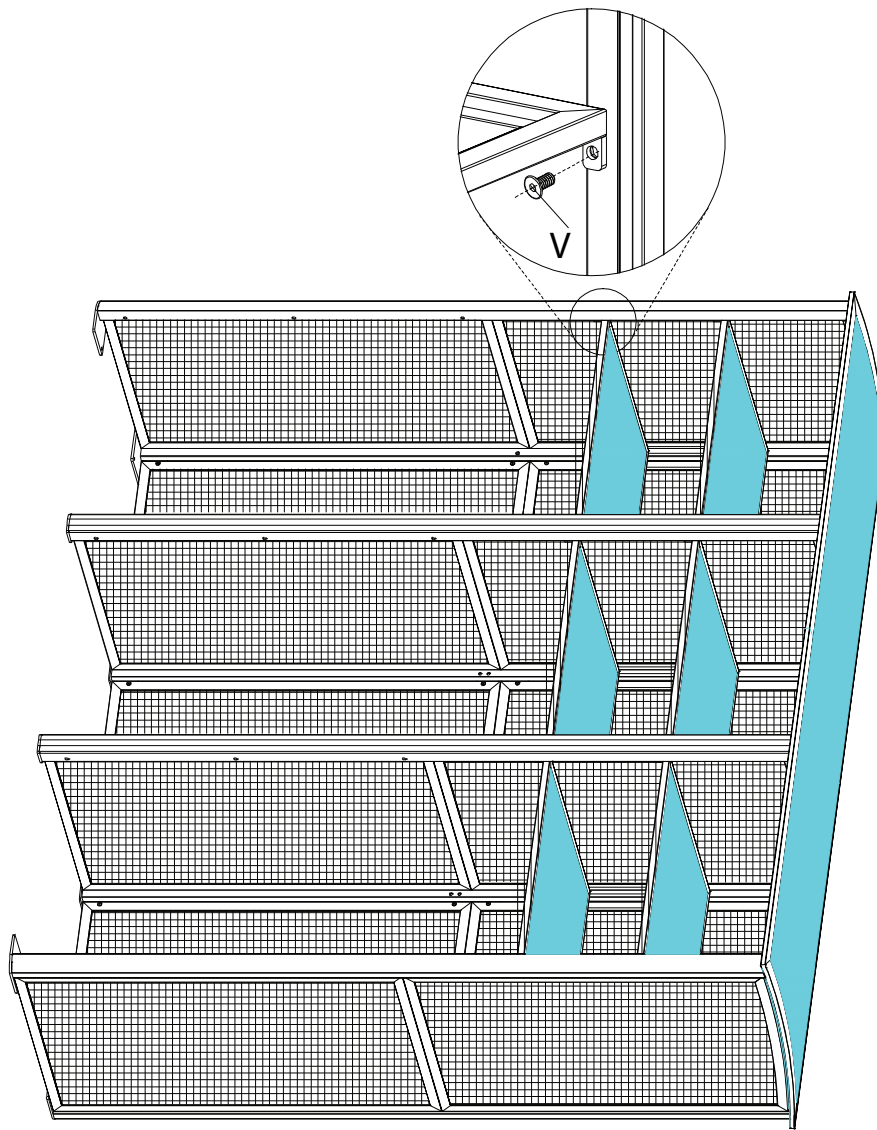

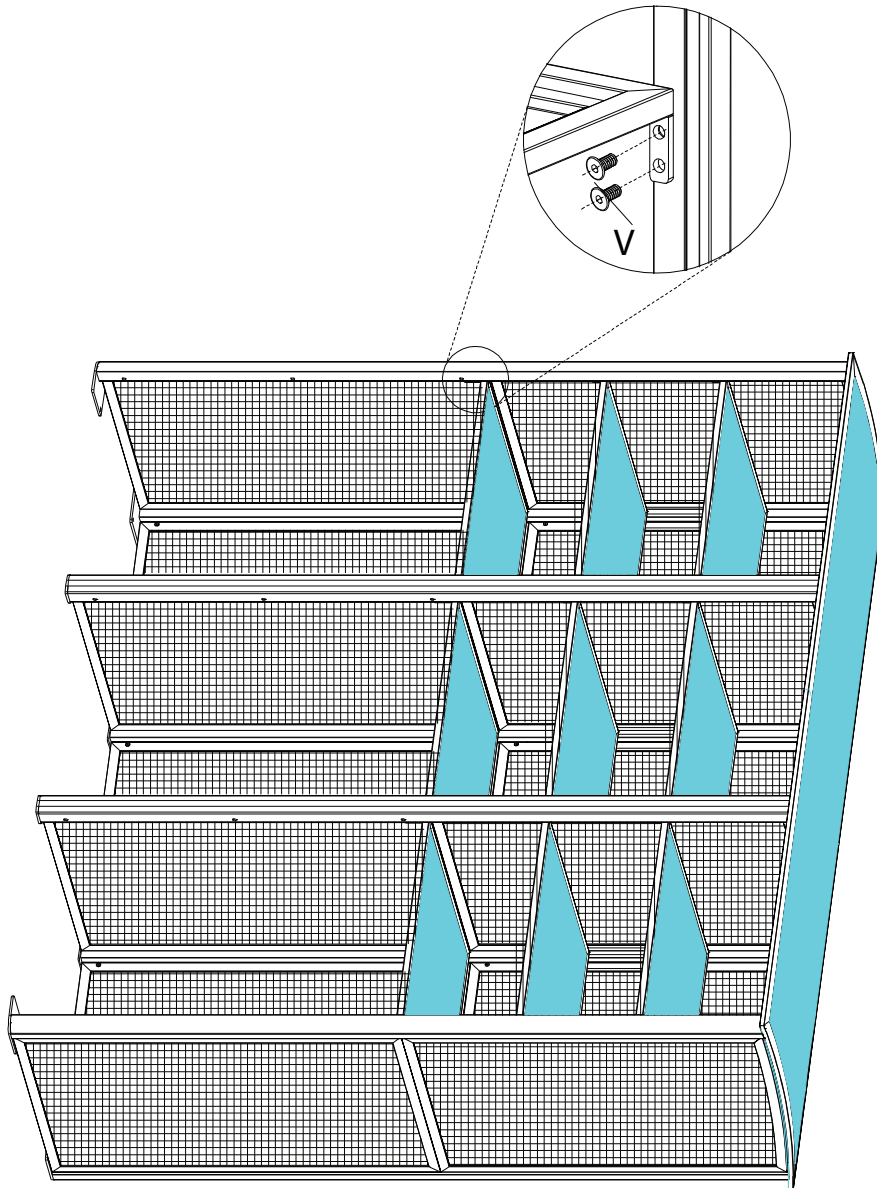

When assembling your Towel Valet, you have the option to assemble as many as 3 shelves per unit. However, the assembly of the first shelf from the bottom is required for each unit as it provides the proper rigidity to the entire structure. This bottom shelf is attached to the unit with 8 screws (2 per corner versus 1 for the other shelves).

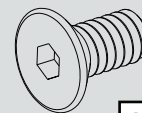
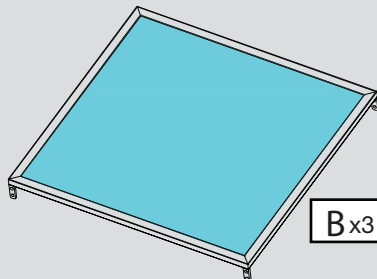
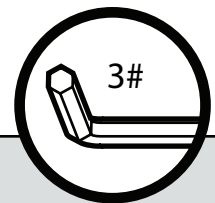



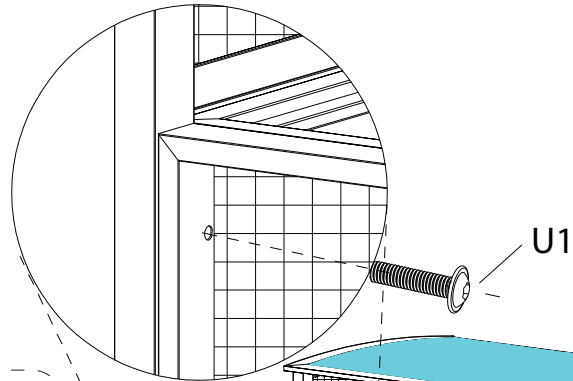

When installing outdoors, the Towel Valet must be attached to the ground. This is a safety precaution (tilting risk due to the wind or human interaction).

Installation by a professional contractor is recommended.

There are 4 attachment points located in the 4 extreme corner plates inside the Towel Valet to be used when securing the product. Use the proper bolts (purchased by you or supplied by your hired professional contractor) for your surface.

For indoor installation, to avoid a tilting risk, we recommend installing the Towel Valet against a wall and attaching it to the ground with the 2 attachment points in the rear. If the Towel Valet is not installed against a wall, we recommend using the 4 attachment points as for an outdoor installation.

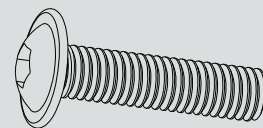
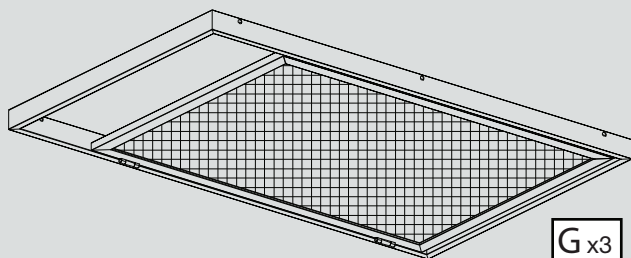
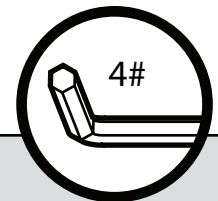
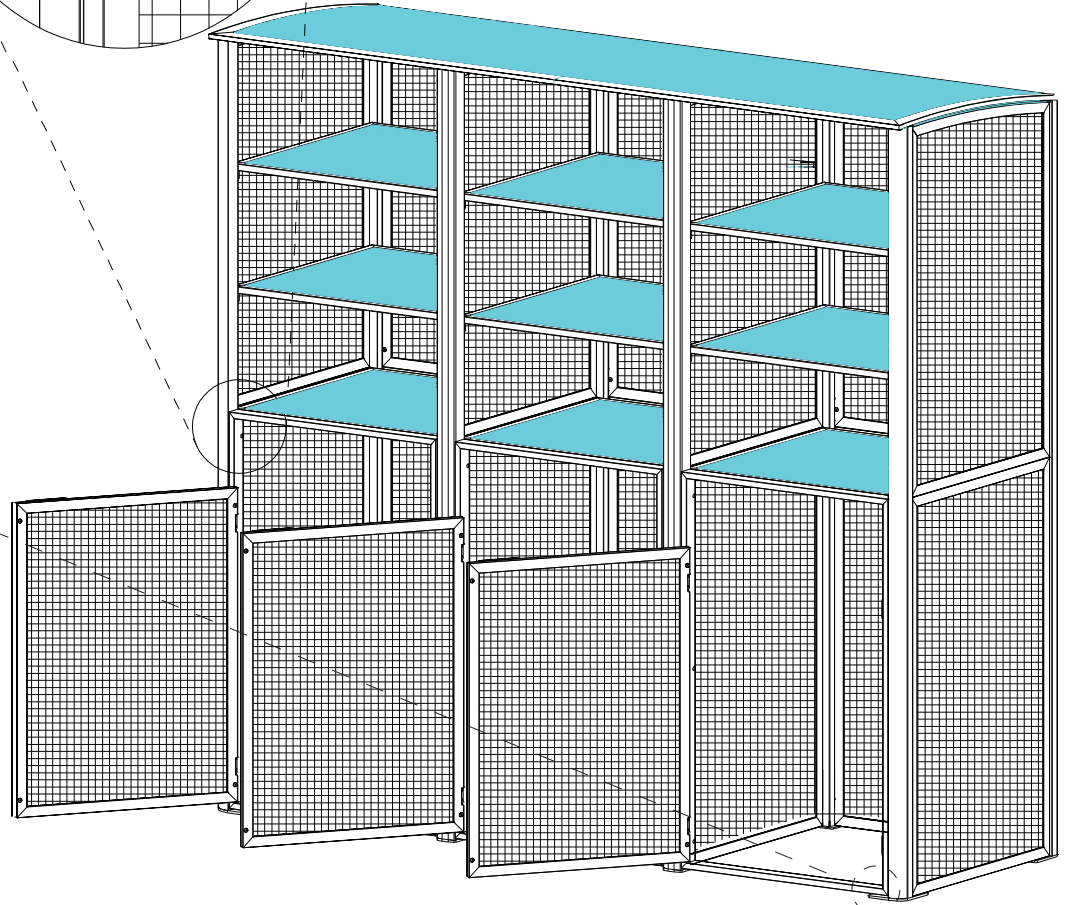
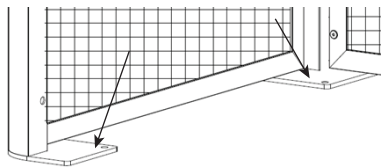

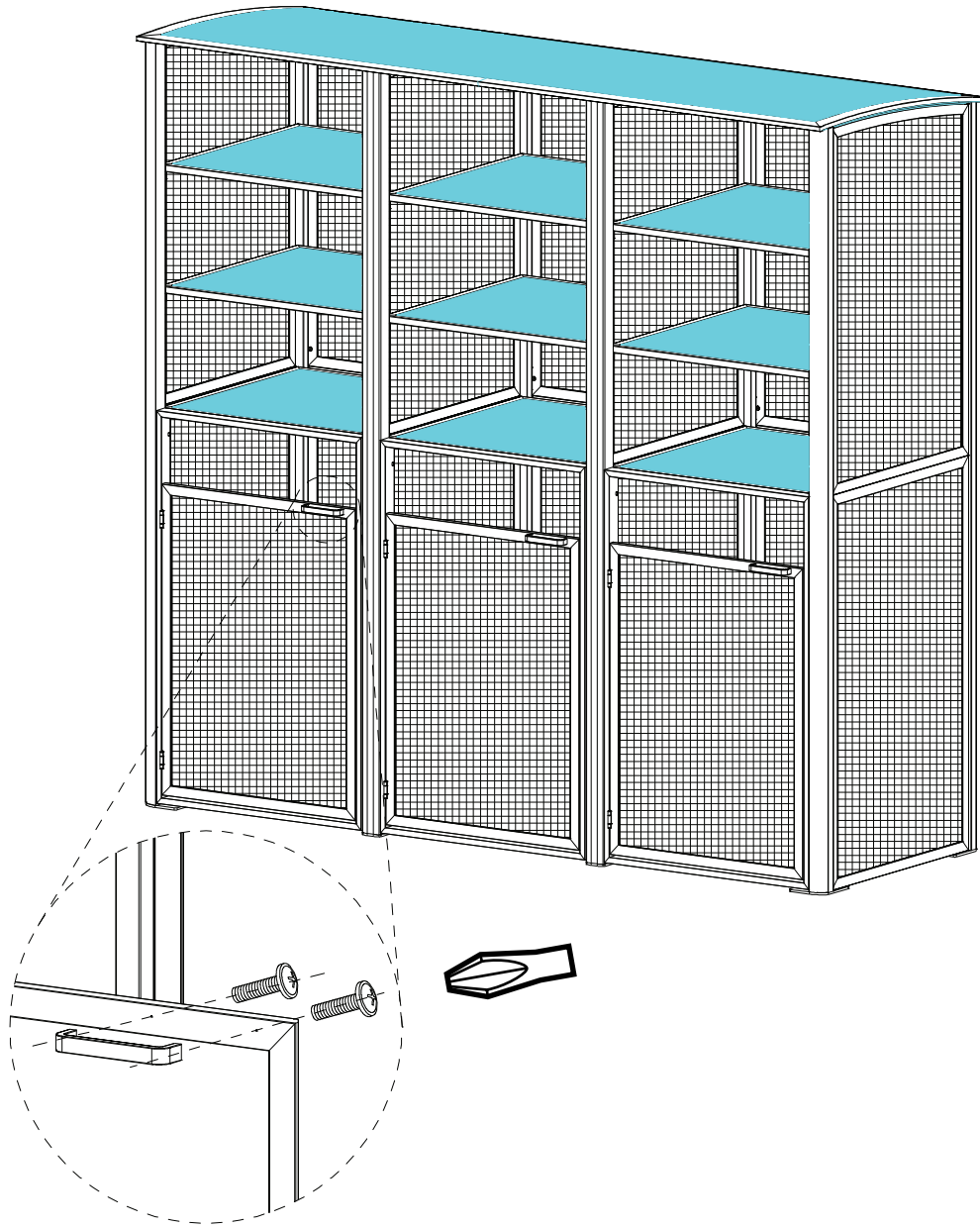

Xx3

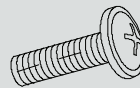

Yx6

**⚠ CAUTION**

- For towel and linen use only
- Follow all manufacturer's assembly instructions
- Fasten unit securely to ground. Professional installation recommended
- Frequently inspect installation fitting/base and tighten as needed
- Do not exceed weight limit of 25 lbs per shelf and 60 lbs per Valet unit
- Do not climb on product
- Moving parts can pinch and cut. Use caution when using this product
- Do not alter or modify this product
- Laundry cart weight limit is 60 lbs
- Keep laundry cart away from children

**⚠ PRUDENCE**

- A n'utiliser que pour les serviettes de bain
- Suivre les instructions d'assemblage du fabricant
- S'assurer que le module est bien fixé au sol. Une installation par un professionnel est recommandée
- S'assurer régulièrement que la structure est bien fixée au sol et ajuster si nécessaire
- Ne pas dépasser la limite de 25 lbs/11 kgs par étagère et 60 lbs/27 kgs par module
- Ne pas grimper sur le produit
- Quelques pièces articulées peuvent pincer ou couper. Utiliser ce produit avec prudence
- Ne pas modifier ce produit
- Le cart peut supporter jusqu'à 60 lbs/27 kgs
- Ne pas laisser le cart à portée des enfants

**⚠ PRECAUCIÓN**

- Para uso exclusivo de toallas y ropa de cama
- Siga todas las instrucciones de montaje del fabricante
- Sujete firmemente la unidad al suelo. Se recomienda instalación profesional
- Inspeccione con frecuencia la instalación/base y apriete según sea necesario
- No exceda el límite de peso de 11 kgs por estante y 27 kgs por unidad de valet
- No trepar sobre el producto
- Las partes móviles pueden pellizcar y cortar. Tenga cuidado al usar este producto
- No alterar ni modificar este producto
- El límite de peso del carrito de lavandería es de 27 kgs
- Mantenga el carrito de lavandería lejos del alcance de los niños

