

Sunset Chaise Lounge

Seat Height: 15"
 Sleigh Length: 75.5"
 Width: 30"
 Unit Weight: 38.3lbs

Product Specifications

Product Description	Reference Number	Color	UPC Code 014306	Weight Each (lbs.)	Master Pack	Master Pack Volume (cu. ft)	
Sunset Chaise Lounge	US642599	Cognac/Fusion Bz	930879	44.20	12	114.64	
	US246599	Cognac/Fusion Bz	930879	47.70	2	31.92	
	UT642288	Solid Gray/Vol Blk	943961	44.20	12	114.64	
	UT246288	Solid Gray/Vol Blk	943961	47.70	2	31.92	
	US642289	Solid Gray/Plat Gray	930886	44.20	12	114.64	
	US246289	Solid Gray/Plat Gray	930886	47.70	2	31.92	
	US330096	White/Glacier Wh	921617	44.20	12	114.64	
	US033096	White/Glacier Wh	921617	47.70	2	31.92	
	UT023599	Beige/Fusion Bz	943947	44.20	12	114.64	
	UT320599	Beige/Fusion Bz	943947	47.70	2	31.92	
	US021096	Madras Blue/Glacier Wh	933917	44.20	12	114.64	
	US120096	Madras Blue/Glacier Wh	933917	47.70	2	31.92	
	UT023096	Beige/Glacier Wh	943930	44.20	12	114.64	
	UT320096	Beige/Glacier Wh	943930	47.70	2	31.92	
	US021288	Madras Blue/Vol Blk	933979	44.20	12	114.64	
	US120288	Madras Blue/Vol Blk	933979	47.70	2	31.92	

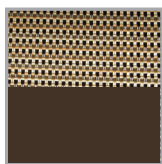

Cognac/
Fusion Bronze

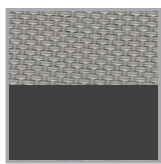

Solid Gray/
Volcanic Black

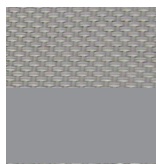

Solid Gray/
Platinum Gray

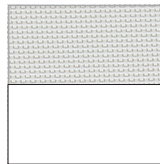

White/
Glacier White

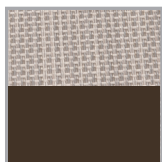

Beige/
Fusion Bronze



Madras Blue/
Glacier White

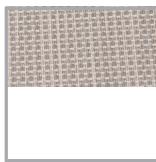

Beige/
Glacier White



Madras Blue/
Volcanic Black



Sunset Chaise Lounge

Features & Benefits

Warranty: 3 Yrs. on Frame + 3 Yrs. on Slings

- Passes ASTM F 1988-99 Class B performance standard for commercial outdoor lounging
- Made of Grosfillex® new technopolymer with Air Molding Technology (AMT) to increase durability with the strength of metal
- Sophisticated and versatile: Perfect for relaxing in luxurious settings - from pools & spas to ski & beach resorts
- ASTM Rated for Safe Commercial Use
- Rust & U.V. resistant - Easy to clean and to maintain
- Recessed wheels for ease of relocation
- Replaceable sling has Microban® anti-microbial treatment
- Stacks for easy storage
- 100% recyclable

Elegant Sunset design for relaxing comfort. Coordinates with all of the Sunset Collection.

Spare Parts

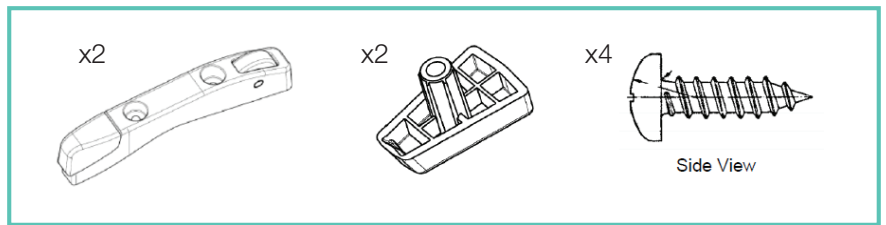
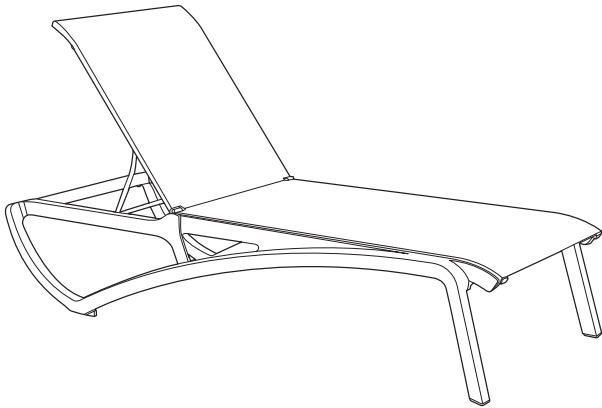

Footpads USSP0301 & USSP0310



Reference	Description
USSP0301	FOOTPADS SET SUNSET CHAISE NATURAL
USSP0310	FOOTPADS SET SUNSET CHAISE BLACK
USSP0323	REPL SLING HDW KIT SUNSET BDS