

Sunset Chaise Lounge

Seat Height: 15"
 Sleigh Length: 75.5"
 Width: 30"
 Unit Weight: 38.3lbs

Product Specifications

Product Description	Reference Number	Color	UPC Code 014306	Weight Each (lbs.)	Master Pack	Master Pack Volume (cu. ft)	
Sunset Chaise Lounge	UT740599	Cognac/Fusion Bz	946764	44.20	12	114.64	
	UT047599	Cognac/Fusion Bz	946764	47.70	2	31.92	
	UT740288	Solid Gray/Vol Blk	946740	44.20	12	114.64	
	UT047288	Solid Gray/Vol Blk	946740	47.70	2	31.92	
	UT740289	Solid Gray/Plat Gray	946757	44.20	12	114.64	
	UT047289	Solid Gray/Plat Gray	946757	47.70	2	31.92	
	UT740096	White/Glacier Wh	946733	44.20	12	114.64	
	UT047096	White/Glacier Wh	946733	47.70	2	31.92	
	UT741599	Beige/Fusion Bz	946726	44.20	12	114.64	
	UT147599	Beige/Fusion Bz	946726	47.70	2	31.92	
	UT741096	Madras Blue/Glacier Wh	946696	44.20	12	114.64	
	UT147096	Madras Blue/Glacier Wh	946696	47.70	2	31.92	
	UT742096	Beige/Glacier Wh	946719	44.20	12	114.64	
	UT247096	Beige/Glacier Wh	946719	47.70	2	31.92	
	UT741288	Madras Blue/Vol Blk	946702	44.20	12	114.64	
	UT147288	Madras Blue/Vol Blk	946702	47.70	2	31.92	

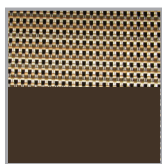

Cognac/
Fusion Bronze

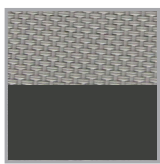

Solid Gray/
Volcanic Black

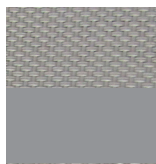

Solid Gray/
Platinum Gray

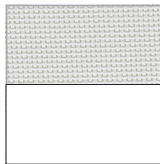

White/
Glacier White

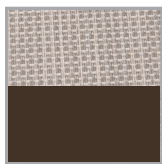

Beige/
Fusion Bronze



Madras Blue/
Glacier White

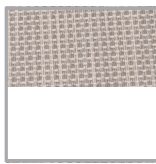

Beige/
Glacier White



Madras Blue/
Volcanic Black



Sunset Chaise Lounge

Features & Benefits

Warranty: 3 Yrs. on Frame + 3 Yrs. on Slings

- Passes ASTM-B performance standard for commercial outdoor lounging
- Made of Grosfillex® new technopolymer with Air Molding Technology (AMT) to increase durability with the strength of metal
- Sophisticated and versatile: Perfect for relaxing in luxurious settings - from pools & spas to ski & beach resorts
- ASTM Rated for Safe Commercial Use
- Rust & U.V. resistant - Easy to clean and to maintain
- Recessed wheels for ease of relocation
- Slings has Microban® anti-microbial treatment
- Stacks for easy storage
- 100% recyclable

Spare Parts

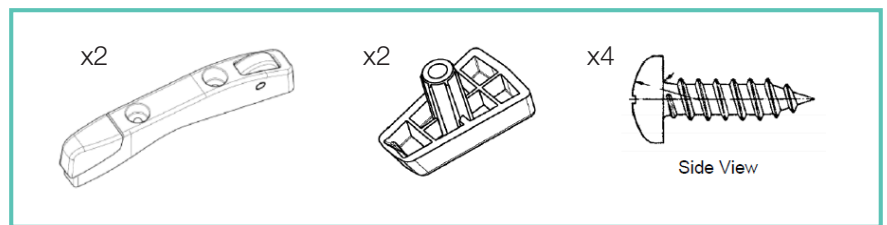
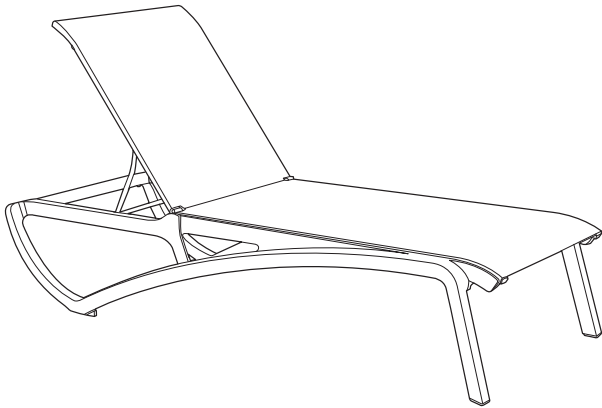

Footpads USSP0301 & USSP0310



Reference	Description
USSP0301	FOOTPADS SET SUNSET CHAISE NATURAL
USSP0310	FOOTPADS SET SUNSET CHAISE BLACK
USSP0323	REPL SLING HDW KIT SUNSET BDS